



Client:	
Order #:	
Project:	
Type:	

DESCRIPTION

The Grada garage LED fixture boasts a sleek and minimalist appearance, perfectly aligned with modern aesthetics. Its simple and lightweight structure enhances the overall ambiance, eliminating the "cave effect" commonly associated with traditional parking garage lights. With uplight as a standard design feature, these fixtures are ideal for applications where ambiance is crucial, ensuring a well-balanced and inviting environment.

FEATURES

- ADC12 die-casting aluminum, which has excellent heat dissipation effect.
- High output efficiency up to 165lm/W.
- PIR/microwave sensor are optional.
- 3CCT & 4 power adjustable.
- Up light switch as standard.
- The uplight flux accounts for 5%-10% of the total fixture light flux.
- Emergency backup available.
- 3/4"NPT mount and ceiling mount are available.
- IP65 &IK08.

PERFORMANCE DATA

CRI

80+

CCT

3000K, 4000K, 5000K

Projected Lifetime

>50,000 Hours (L80)

Dimming

0-10V Dimming Standard,
10% down to 100%

Operating Temperature

-30°C to +50°C Ambient

Warranty

5 year Standard
10 year Optional

ORDERING INFORMATION

GRADA						
--------------	--	--	--	--	--	--

A		B	C	D	E	F		G
FIXTURE SERIES			CCT			OPTIONS		
Grada			30	3000K		EM	Emergency kit	
WATTAGE/LUMENS			40	4000K		PIR	PIR sensor	
25	25W/4125 ¹		50	5000K		MS	Motion sensor	
40	40W/6600 ¹		VOLTAGE			BS	Bird Spike	
60	60W/9900 ¹		UNV	120-277V		WG	Wire Guard	
80	80W/13200 ¹		FINISH			HS	House Side Shield	
100	100W/16500 ¹		WH	White		WARRANTY²		
						-	5 Year Warranty	
						10	10 Year Warranty	
						10L	10 Year Warranty including labor	

¹Delivered Lumens (4000K)

² 5 Year Warranty is Standard unless specified

DIMENSIONS

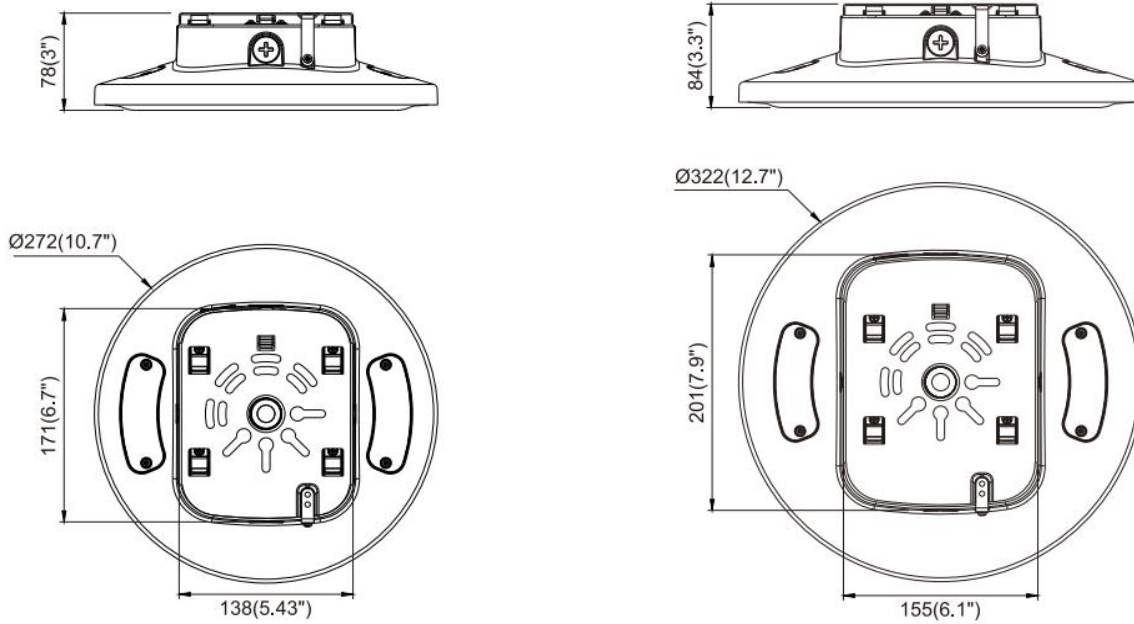

ACCESSORIES



Motion sensor
PC
Φ52*20mm

Code: MS



PIR sensor
PC
Φ61*28mm

Code: PIR

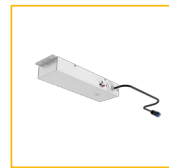

Emergency kit
SPCC
8W1.5H emergency backup
Operating Voltage: 120-277V
IP Rating:IP20
Code: EM

PHOTOMETRY

25W/40W/60W beam angle

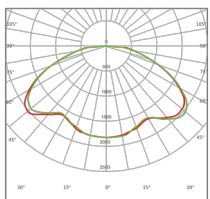

80W/100W beam angle

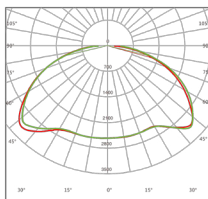

MOUNTING OPTIONS



UP LIGHT MODULE

Grada has uplight as standard, which would reduce cave effect
The uplight flux accounts for 5%-10% of the total fixture light flux.

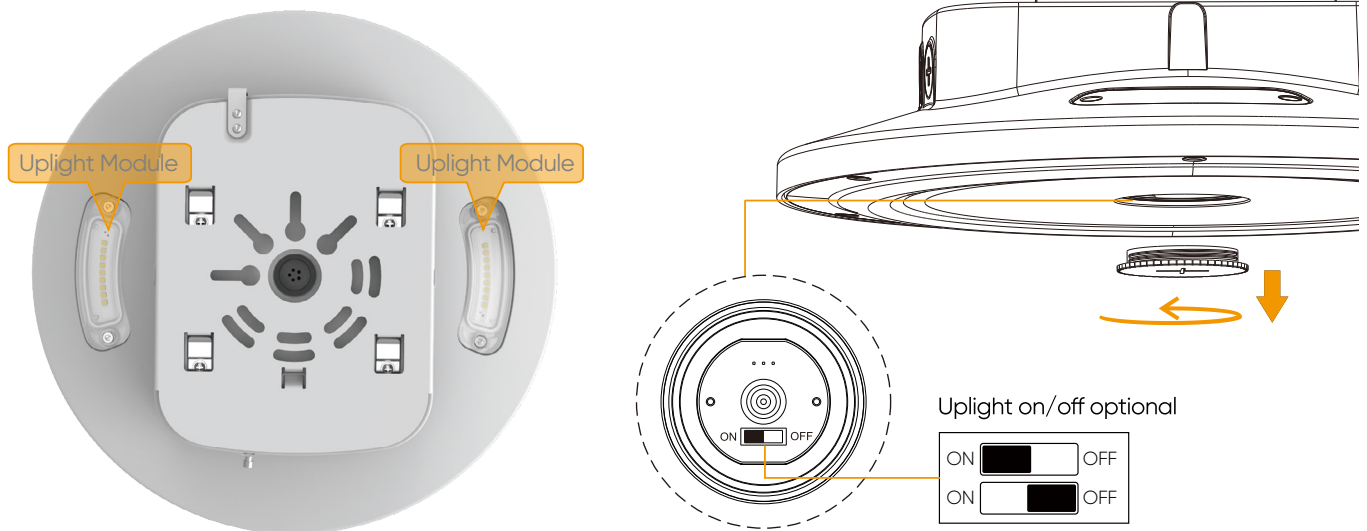

EMB AVAILABLE

External emergency battery is available, which would be connected through a quick connector, allowing the fixture to work 1.5 hrs when there is a blackout.



ACCESSORIES

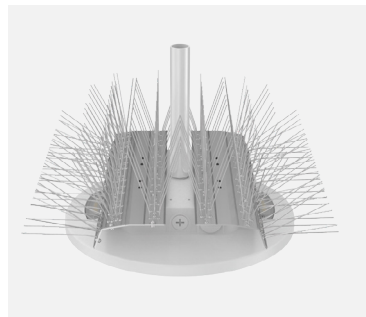

Bird Spike



Wire Guard



House Side Shield

FIELD ADJUSTABLE

• 3 CCT Adjustable

3000K, 4000K, 5000K adjustable

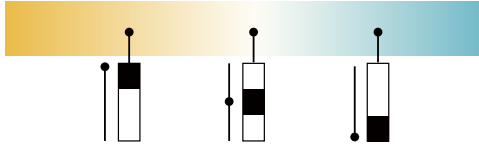

Power	100%	75%	50%	30%
25W	25W	19W	13W	7.5W
40W	40W	30W	20W	12W
60W	60W	45W	30W	18W
80W	80W	60W	40W	24W
100W	100W	75W	50W	30W

• 4 Wattage Adjustable

30%, 50%, 75%, 100% adjustable

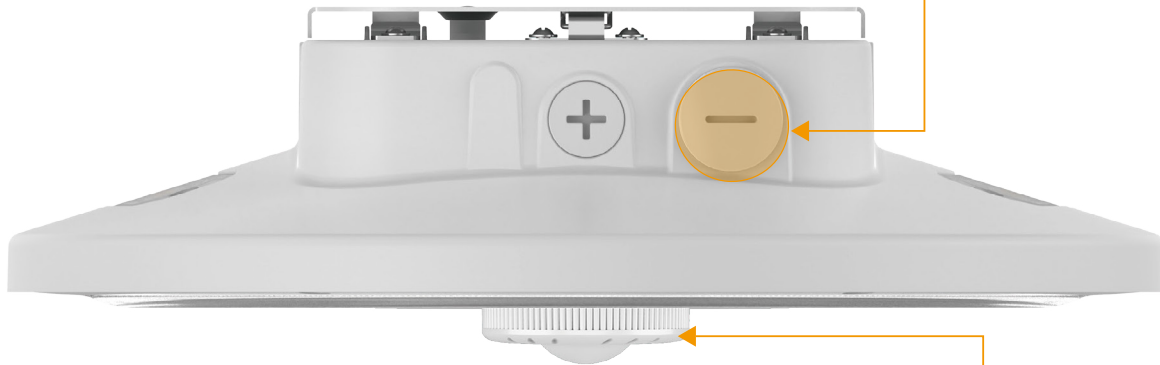
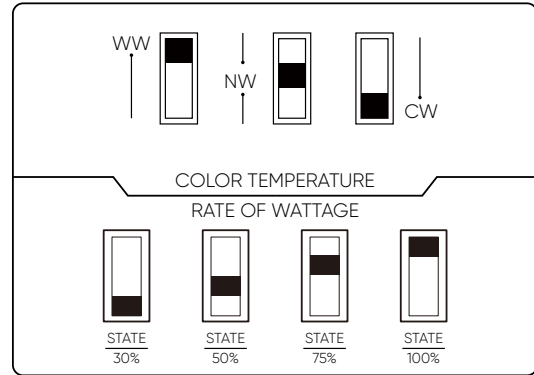
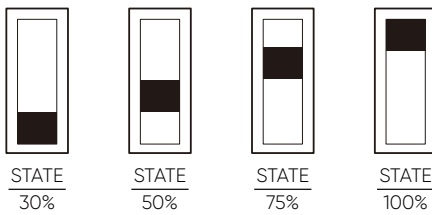

MICROWAVE & PIR SENSOR

Plug-and-play Microwave and PIR sensor control make it more energy-saving based on 160lm/w and saves your electric bills.



Microwave Motion Sensor



PIR Sensor